

Image not found

https://sites.msudenver.edu/tpswesternregion/wp-content/uploads/sites/476/2021/11/tps_logo-1.png

ALBUM PRIMARY SOURCES AND PICTURE BOOKS: EARMUFFS FOR EVERYONE! BY MEGHAN MCCARTHY

Album Description

Primary Sources associated with the book Earmuffs for Everyone!

PATENT 188292 EAR-MUFFLERS

C. GREENWOOD.
EAR-MUFFLERS.

No. 188,292.

Patented March 13, 1877.

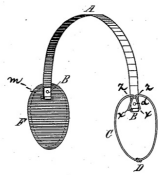

Fig. 1.



Fig. 2.

Witnesses:
Levels, Shaw -
H. E. Metcalf

Inventor
Chester Greenwood,
Per C. C. Shaw

U. S. PATENT OFFICE, WASHINGTON, D. C.

Reference Link:

<http://pdfpiw.uspto.gov/.piw?Docid=188292&idkey=NONE&homeurl=http%3A%252F%252Fpatft.uspto.gov%252F>

PATENT 2066036 METAL RAKE

Dec. 29, 1936. C. GREENWOOD 2,066,036
METAL RAKE
Filed Feb. 2, 1935

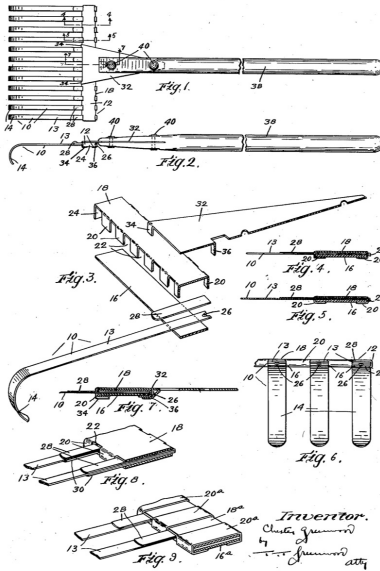

Reference Link:

<http://pdfpiw.uspto.gov/.piw?Docid=2066036&idkey=NONE&homeurl=http%3A%252F%252Fpatft.uspto.gov%252F>

PATENT 1716124 KETTLE

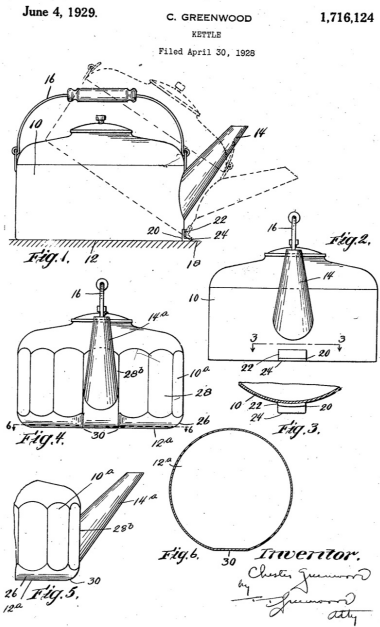

Reference Link:

<http://pdfpiw.uspto.gov/.piw?Docid=1716124&idkey=NONE&homeurl=http%3A%252F%252Fpatft.uspto.gov%252F>

PATENT 138894 EAR PROTECTORS

M. ISIDOR.
Ear-Protectors.

No. 138,894.

Patented May 13, 1873.

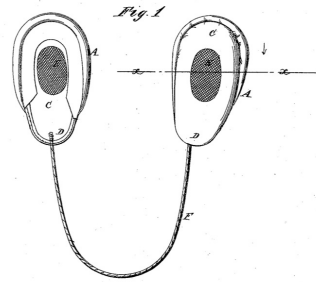

Fig. 1



Fig. 2

Witnesses:
W. H. Hargraves
Blair

Inventor:
M. Isidor
Per *Munn & Co.*
Attorneys.

ALL RIGHTS RESERVED BY THE PATENT OFFICE

Reference Link:

<http://pdfpiw.uspto.gov/.piw?docid=00138894&SectionNum=2&IDKey=09AE745A8355&HomeUrl=http://patft.us>

PATENT 365061 EAR AND NECK PROTECTOR

(No Model.)

2 Sheets—Sheet 1.

L. FRIEDMAN.
EAR AND NECK PROTECTOR.

No. 365,061.

Patented June 21, 1887.

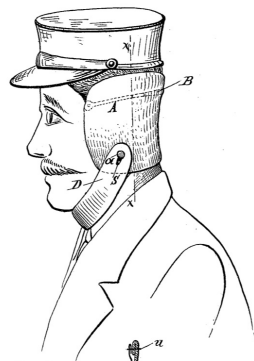

Fig. 1.

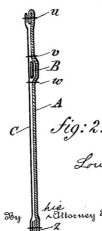

Fig. 2.

Witnesses:
L. P. ...
W. ...

Louis Friedman
Inventor

By *Edward A. ...*
Attorney

W. H. ...

Reference Link:

<http://pdfpiw.uspto.gov/.piw?Docid=365061&idkey=NONE&homeurl=http%3A%252F%252Fpatft.uspto.gov%252F>

PATENT 200085 EAR PROTECTOR

(No Model.)

C. BEARD & C. E. BALDWIN.
EAR PROTECTOR.

No. 280,005.

Patented June 26, 1883.

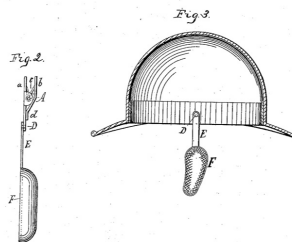
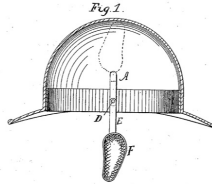

WITNESSES:

H. D. Robinson
S. H. Bond

INVENTORS:

Charles Beard
Charles E. Baldwin
By *J. M. Robertson*
ATTORNEY.

© 1883. Photographic. Watson & Co.

Reference Link:

<http://pdfpiw.uspto.gov/.piw?Docid=280005&idkey=NONE&homeurl=http%3A%252F%252Fpatft.uspto.gov%252F>

PATENT 366788 EAR AND MOUTH PROTECTOR

(No Model.)

L. NEHEMIAS.
EAR AND MOUTH PROTECTOR.

No. 366,788.

Patented July 19, 1887.

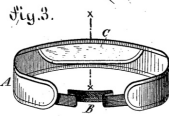

WITNESSES:
Wm. H. Rouse
Paul Van

INVENTOR:
Louis Nehemias
 BY
Joseph P. Rogers
 ATTORNEYS

W. H. Rouse, Washington, D.C.

Reference Link:

<http://pdfpiw.uspto.gov/.piw?Docid=366788&idkey=NONE&homeurl=http%3A%252F%252Fpatft.uspto.gov%252F>

PATENT 351248 FACE PROTECTOR

(No Model.)

A. L. BRITTON,
FACE PROTECTOR.

No. 351,248.

Patented Oct. 19, 1886.

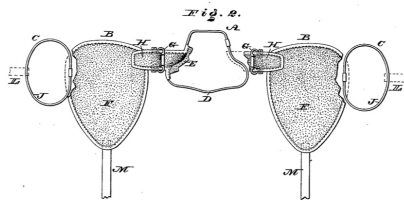
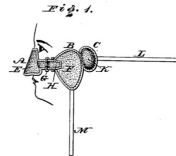

WITNESSES:
E. Howill
H. S. Smith

INVENTOR:
A. L. Britton
BY *Wm. B. Dyer*
ATTORNEY.

A. HENRI, PHOTOGRAPHER, WASHINGTON, D. C.

Reference Link:

<http://pdfpiw.uspto.gov/.piw?docid=00351248&SectionNum=2&IDKey=4C0DEF9438CD&HomeUrl=http://patft.us>

PATENT 190720 EAR SLIPPER

I. B. KLEINERT.
EAR-SLIPPER.

No. 190,720.

Patented May 15, 1877.

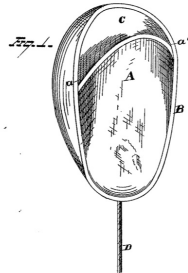

WITNESSES
Edw. A. Nottingham
H. M. Wright

INVENTOR
I. B. Kleinert
By *H. W. Seymour*
ATTORNEY

P. HENRI, PATENT-DRUMMOND, WASHINGTON, D. C.

Reference Link:

<http://pdfpiw.uspto.gov/.piw?Docid=190720&idkey=NONE&homeurl=http%3A%252F%252Fpatft.uspto.gov%252F>

PATENT 20834 EAR CHEEK AND CHIN MUFFS

M. P. Ware.
Ear, Cheek and Chin Muff.
No. 20834.
Patented July 6, 1898.

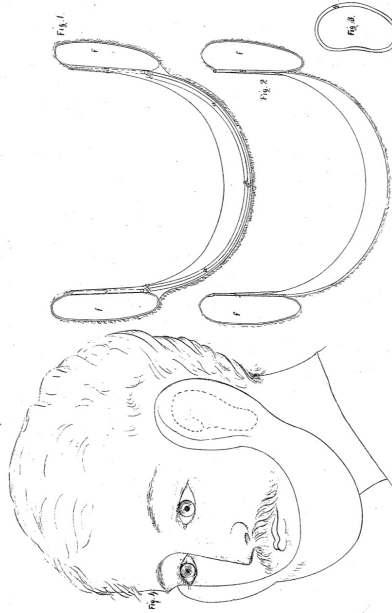

Reference Link:

<http://pdfpiw.uspto.gov/.piw?Docid=20834&idkey=NONE&homeurl=http%3A%252F%252Fpatft.uspto.gov%252F>

PATENT 166900 CAP

A. SCHWARZ.
Cap.

No. 166,900.

Patented Aug. 17, 1875.

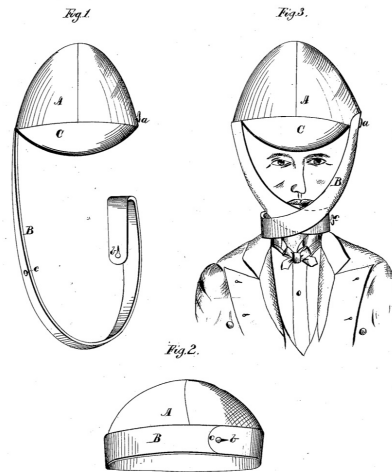

Witnesses:
Chas. Schickel
Chas. Schickel

Inventor:
Adolph Schwarz
per
Geo. Santenich & Hauff
1875

A. HAYES, PHOTO-LITHOGRAPHER, WASHINGTON, D. C.

Reference Link:

<http://pdfpiw.uspto.gov/.piw?Docid=166900&idkey=NONE&homeurl=http%3A%252F%252Fpatft.uspto.gov%252F>

PATENT 202262 CAP AND COLLAR COMBINED

M. ISIDOR.
Cap and Collar Combined.
No. 202,262. Patented April 9, 1878.

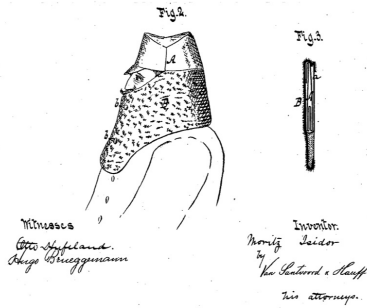
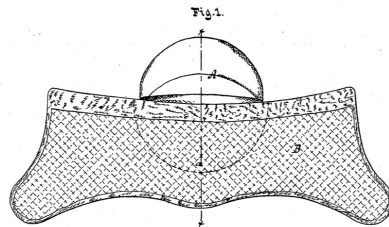

Reference Link:

<http://pdfpiw.uspto.gov/.piw?Docid=202262&idkey=NONE&homeurl=http%3A%252F%252Fpatft.uspto.gov%252F>

Image not found

https://sites.msudenver.edu/tpswesternregion/wp-content/uploads/sites/476/2021/11/tps_logo-1.png

Teaching Notes:

Fabulous combination of literacy, history & STEM  Tom Bober !

Pre K - 2 3 - 5 English/Language Arts Library Social Studies/History STEM

Image not found

https://sites.msudenver.edu/tpswesternregion/wp-content/uploads/sites/476/2021/11/tps_logo-1.png

Teaching Notes:

I think there are some really great learning to be done with this picture books and the patents in this album, especially when you click through to the patent description. This one was fun to put together!